

20111 (VW, Seat, Peugeot)
 20110 = 20111 + A

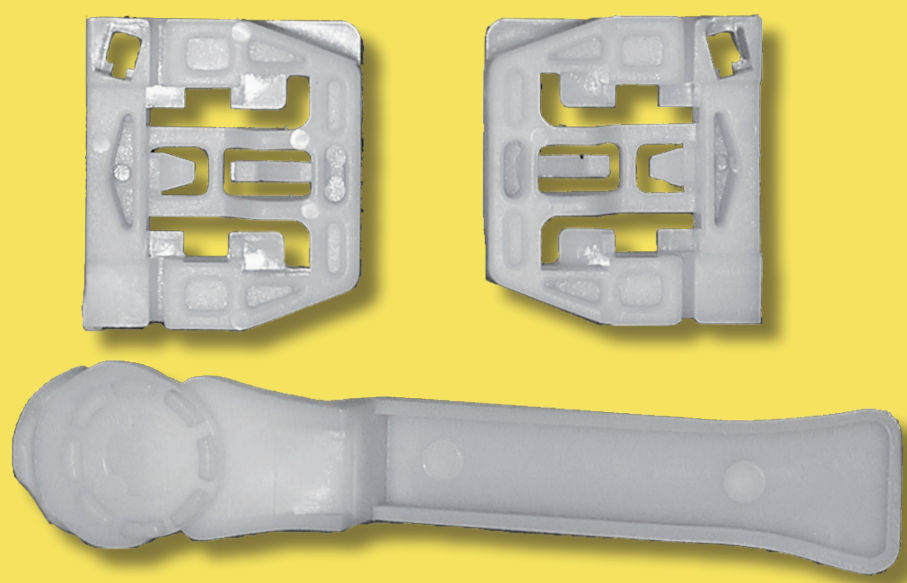

20119 (Skoda)
 20118 = 20119 + B

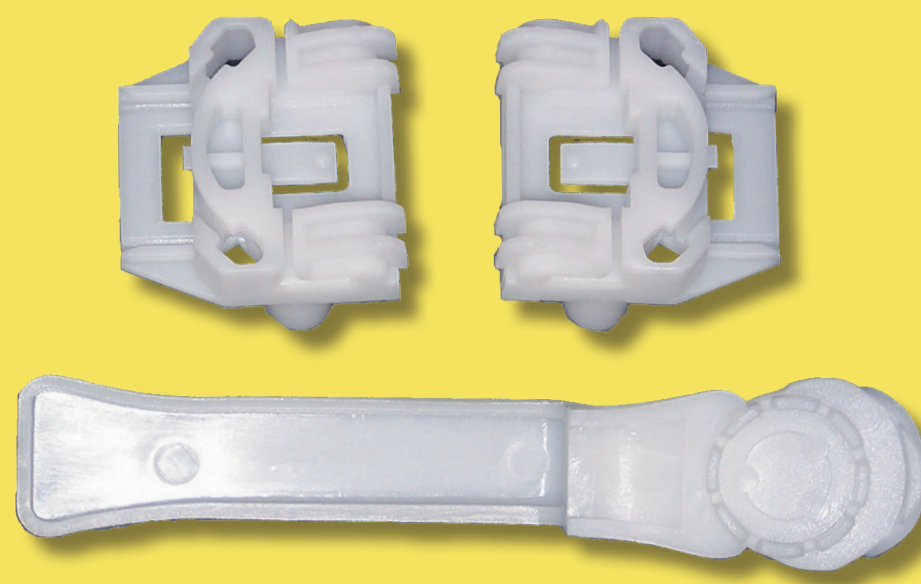

20121 (VW, Seat, Skoda)
 20120 = 20121 + A

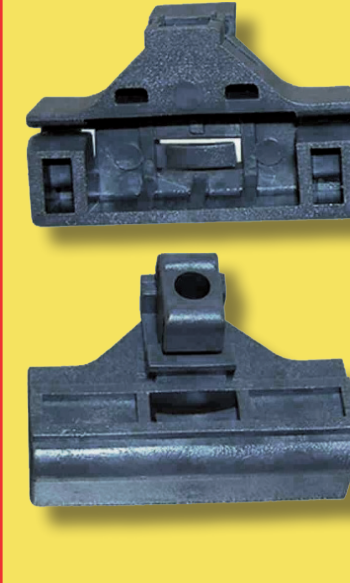

20122 (VW, Seat)

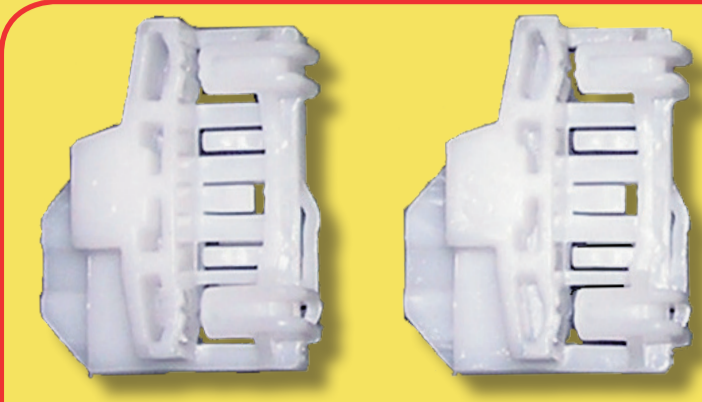

20123 (Audi, VW, Skoda)

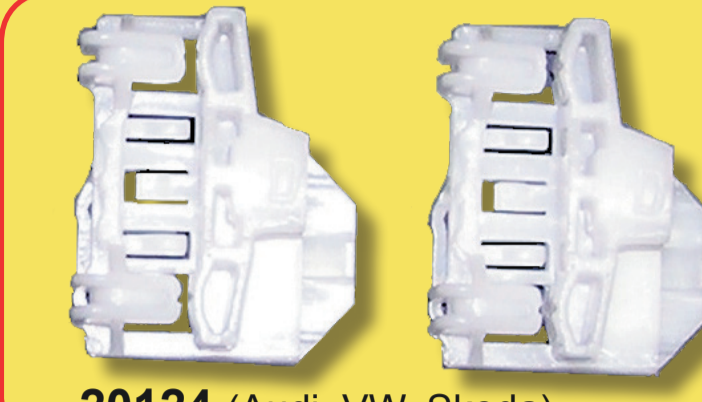

20124 (Audi, VW, Skoda)

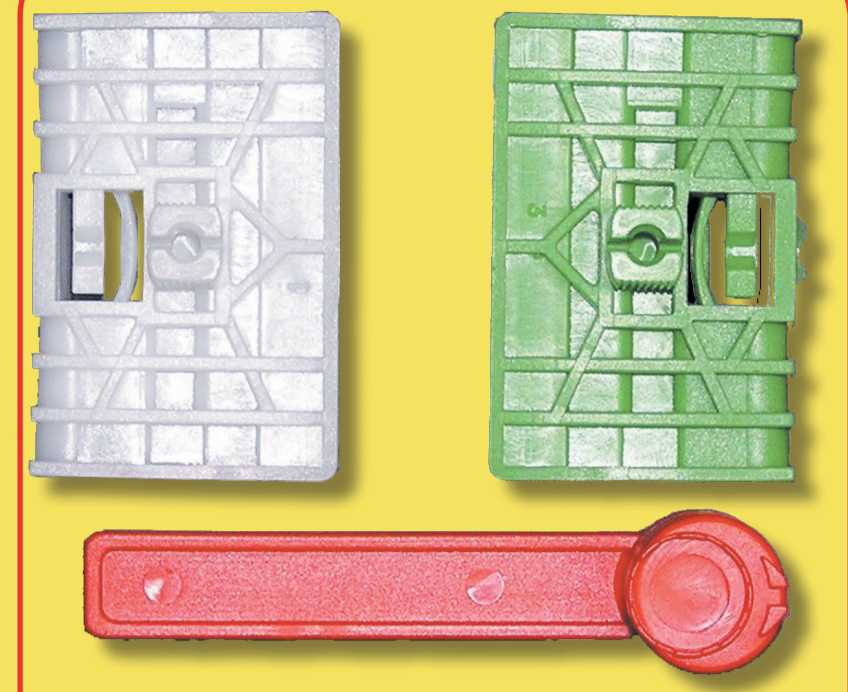

20126 (Audi)

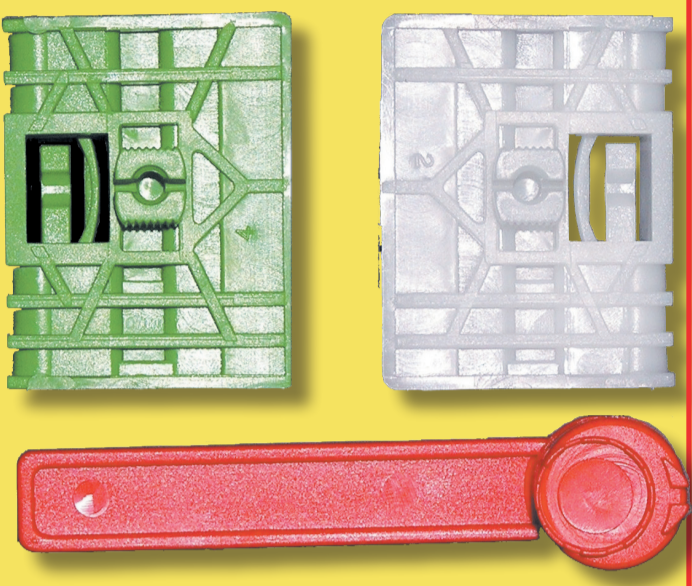

20128 (Audi)

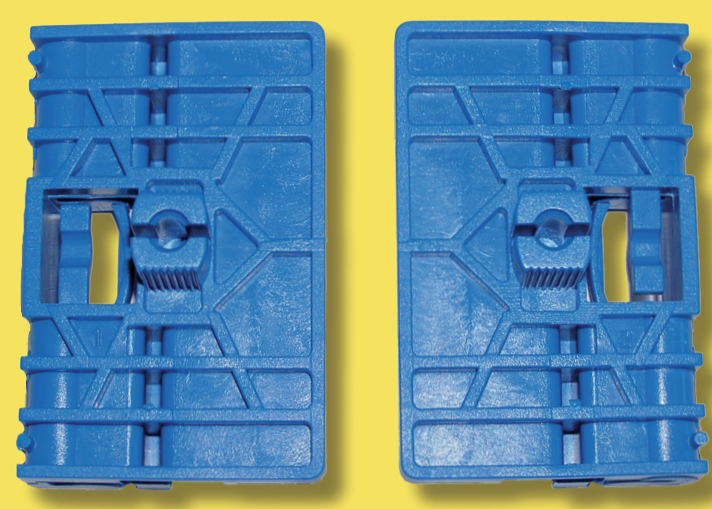

20129 (Audi)

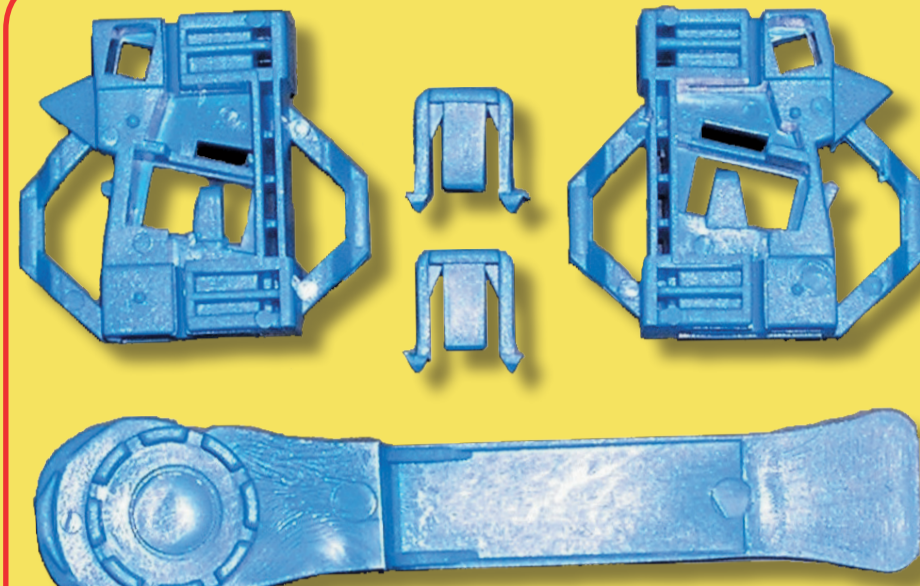

20139 (VW, Seat)
 20138 = 20139 + C

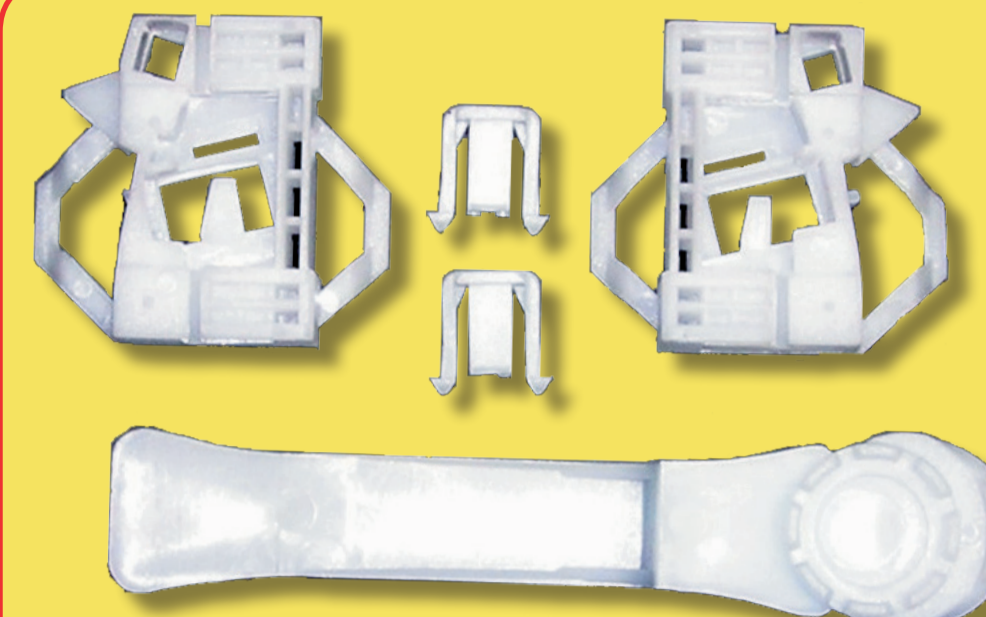

20202 (VW, Seat)
 20201 = 20202 + C

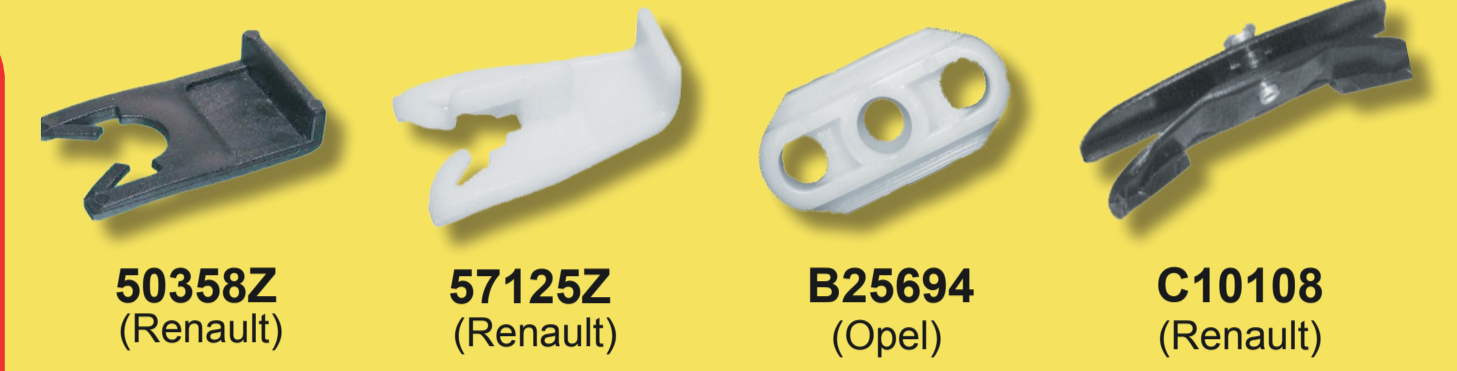

50358Z (Renault)

57125Z (Renault)

B25694 (Opel)

C10108 (Renault)



C10110 (BMW, VW, Volvo)

C10111 (Peugeot)

C10112 (Fiat)

C10431 (Opel)



LISTWA - A
SLAT - A



LISTWA - B
SLAT - B



LISTWA - C
SLAT - C

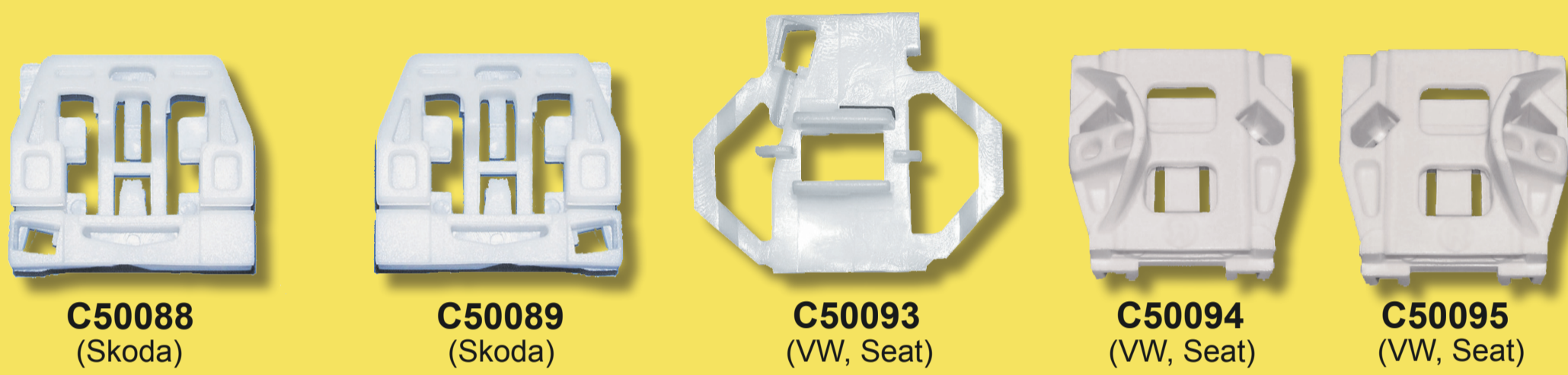

C50088 (Skoda)

C50089 (Skoda)

C50093 (VW, Seat)

C50094 (VW, Seat)

C50095 (VW, Seat)



C50110 (VW, Seat, Peugeot)



C50111 (VW, Seat, Peugeot)

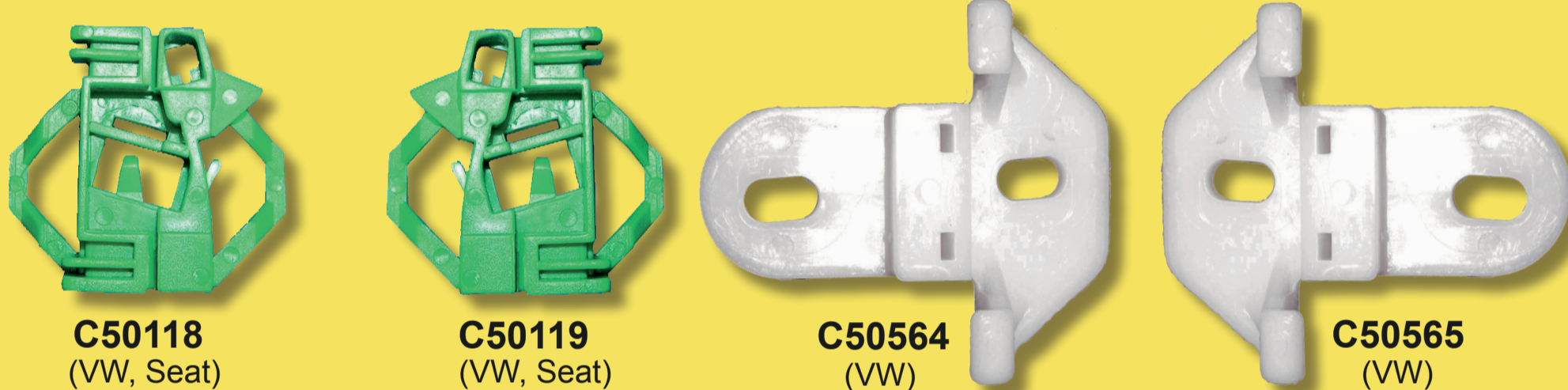

C50118 (VW, Seat)

C50119 (VW, Seat)

C50564 (VW)

C50565 (VW)

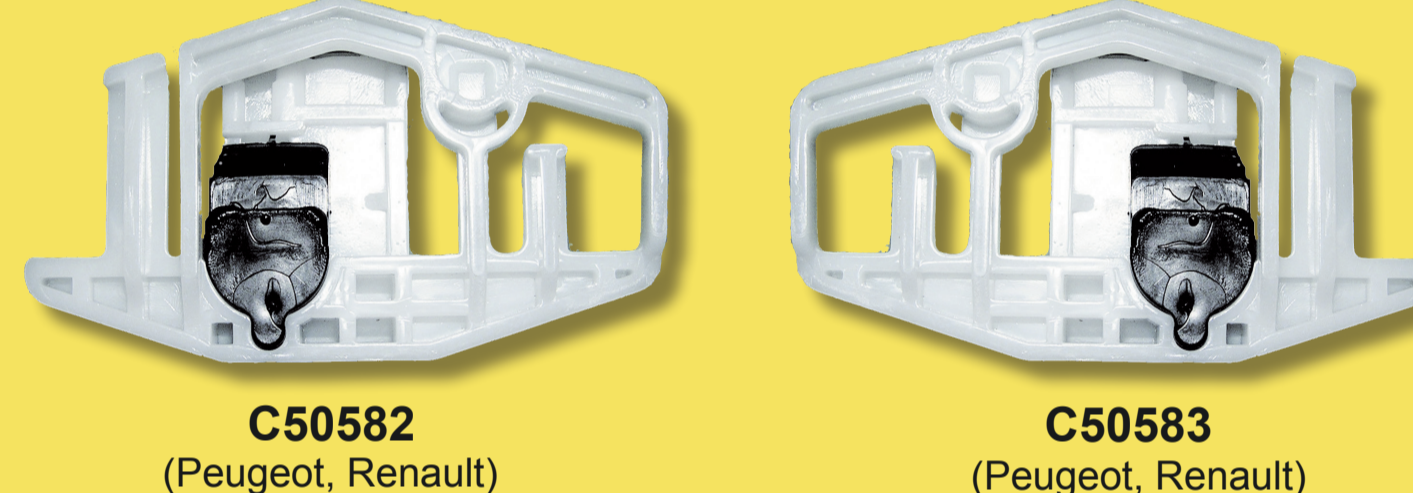

C50582 (Peugeot, Renault)

C50583 (Peugeot, Renault)

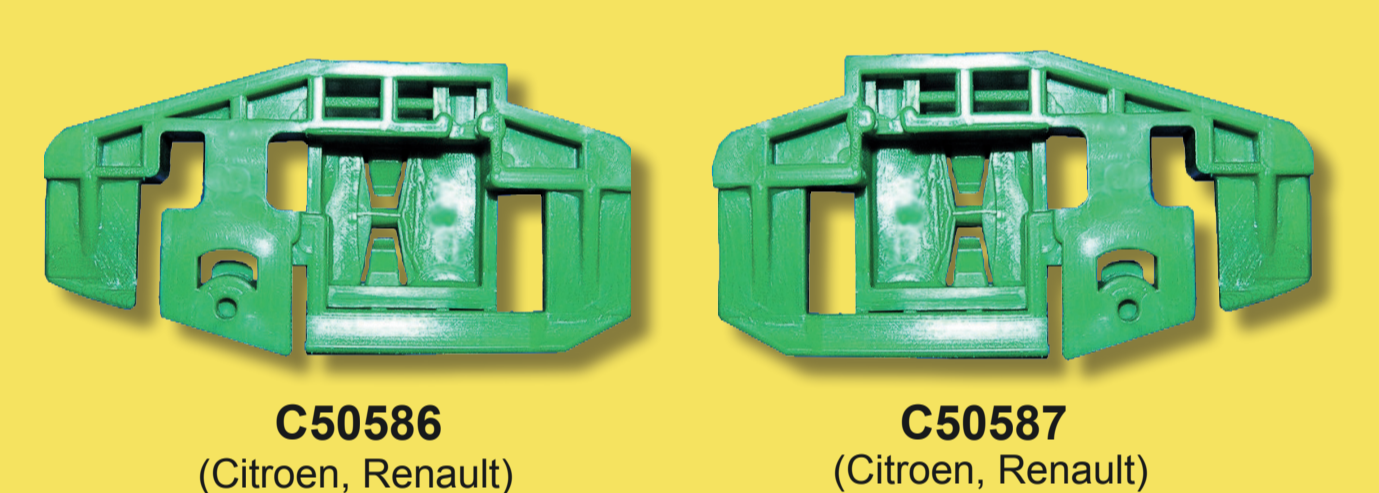

C50586 (Citroen, Renault)

C50587 (Citroen, Renault)

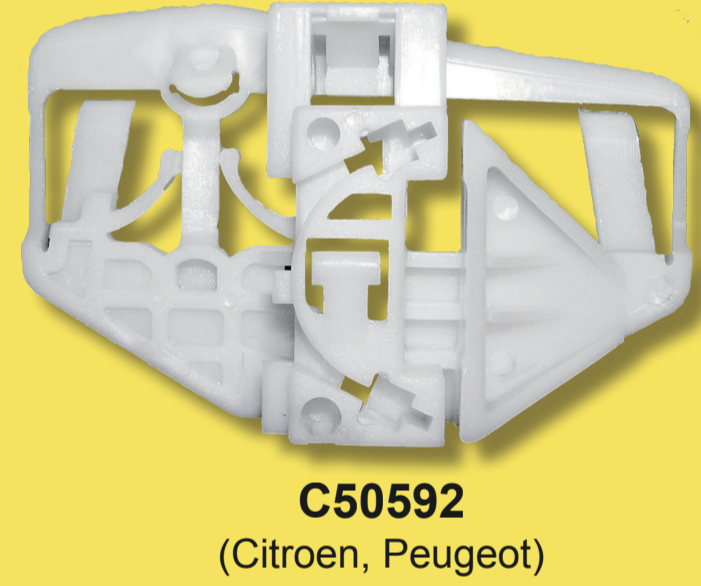

C50592 (Citroen, Peugeot)

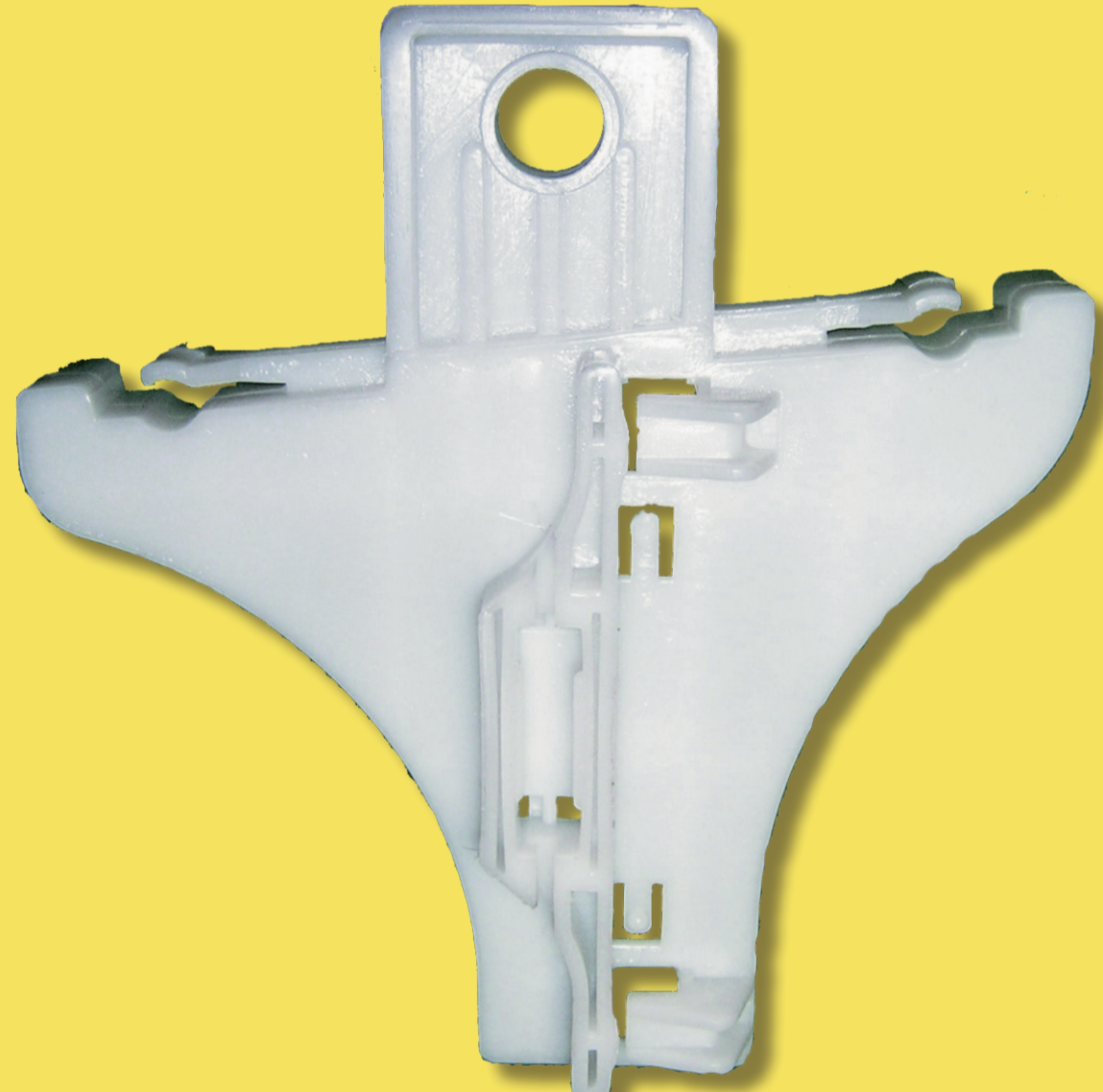

C50604 (VW, Skoda)

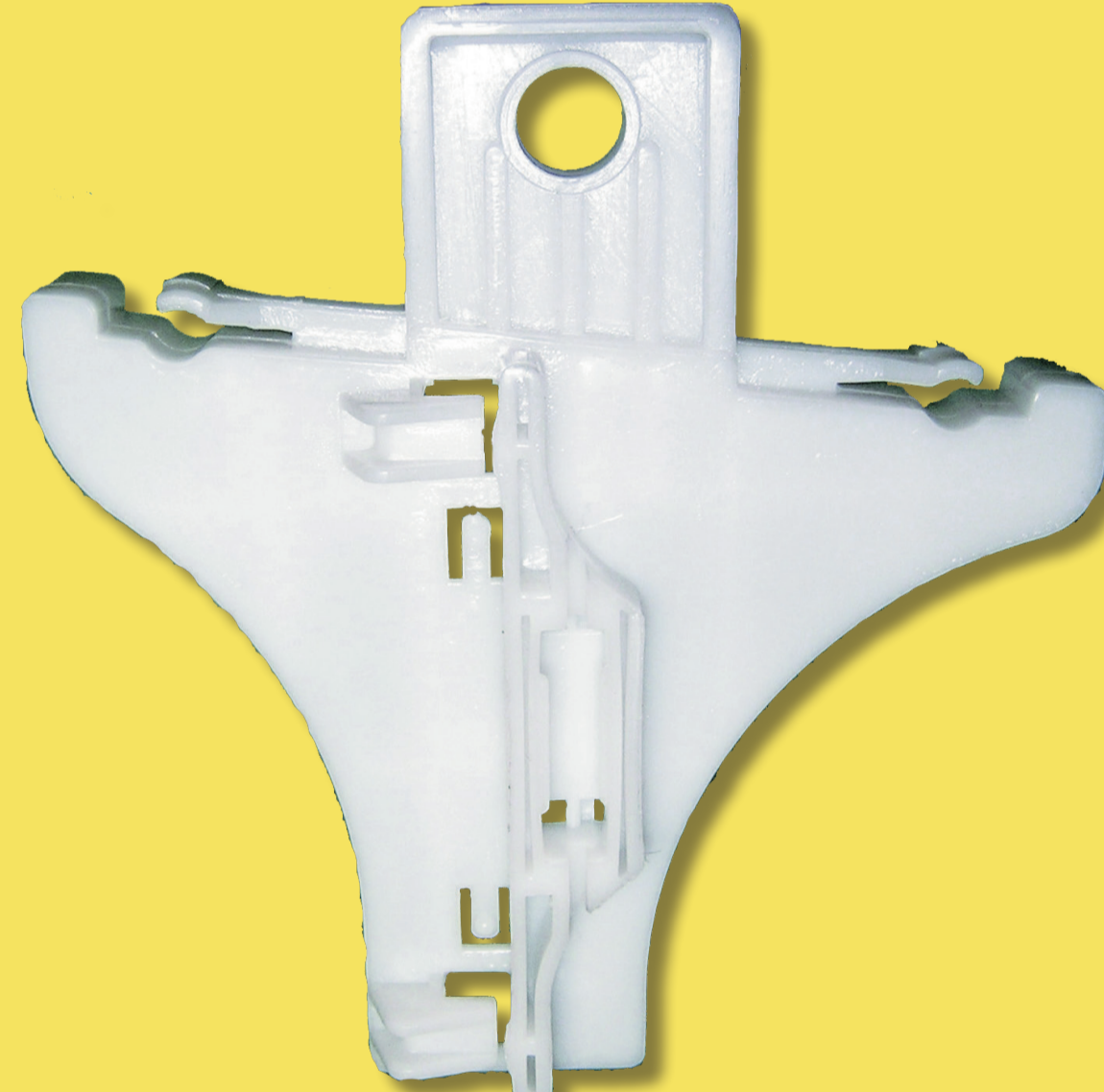

C50605 (VW, Skoda)



C50851 (Ford)



C50852 (Ford)

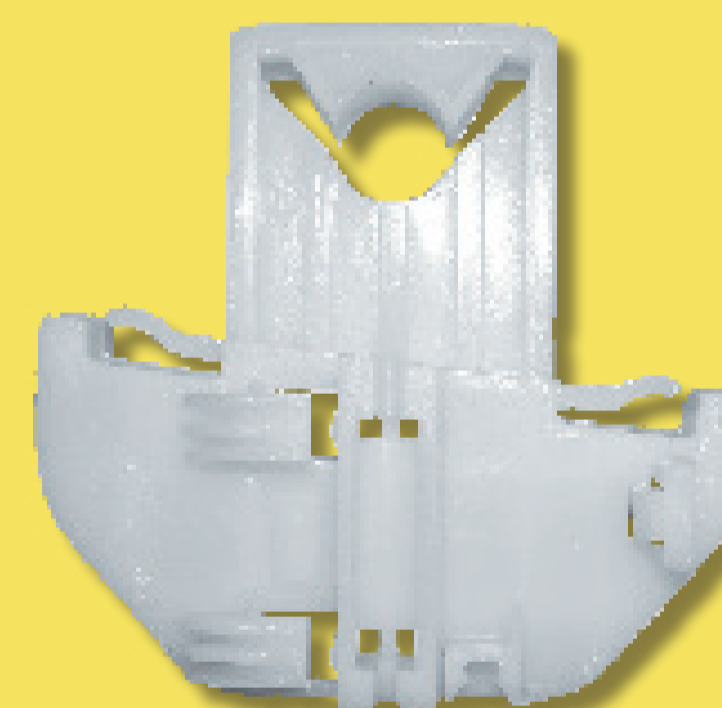

C50850 (Ford)

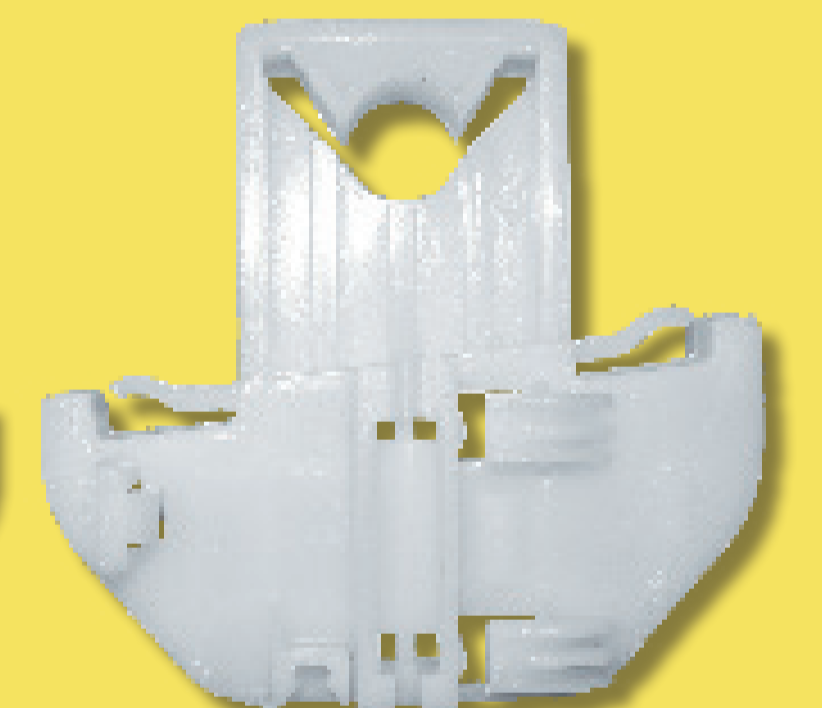

C50853 (Ford)

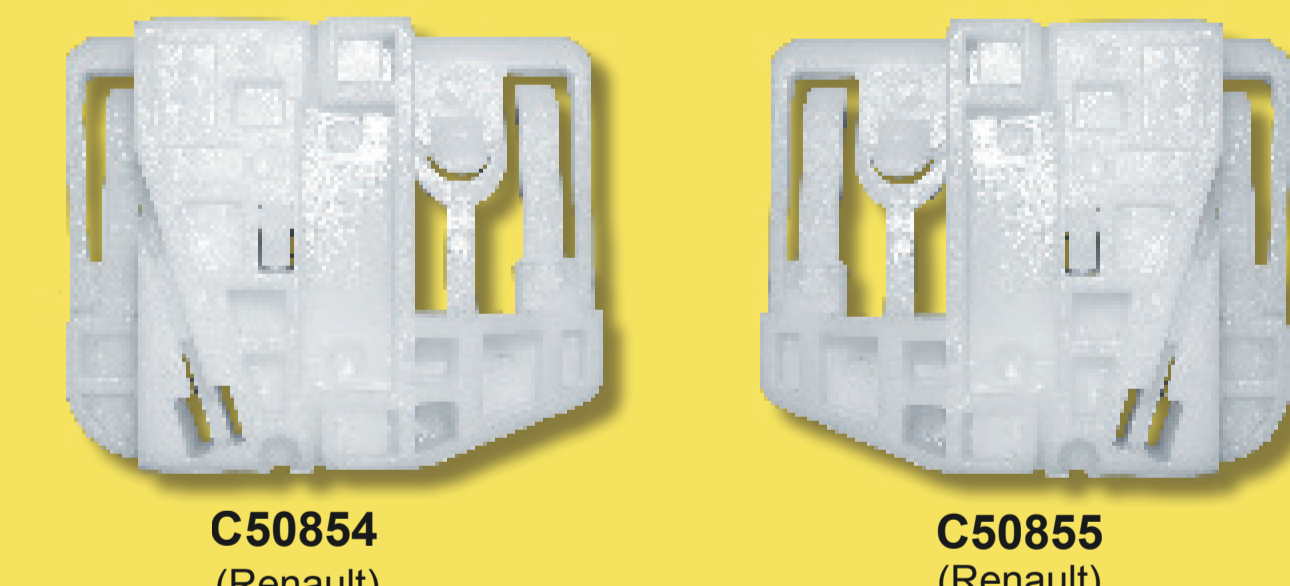

C50854 (Renault)

C50855 (Renault)

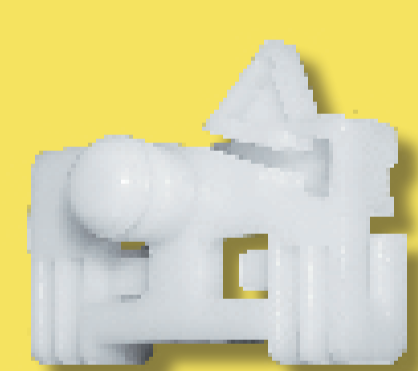

C50856 (Renault)



C50857 (Fiat, Alfa Romeo)



C50858 (Renault)

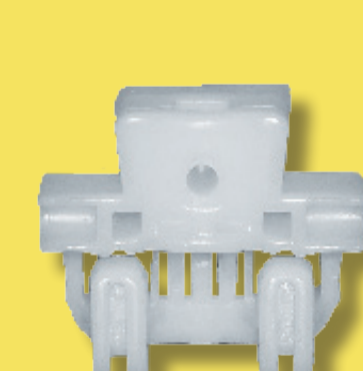

C50859 (Renault)



C50860 (Fiat, Alfa Romeo)



C50861 (Renault)



C50862 (Renault)

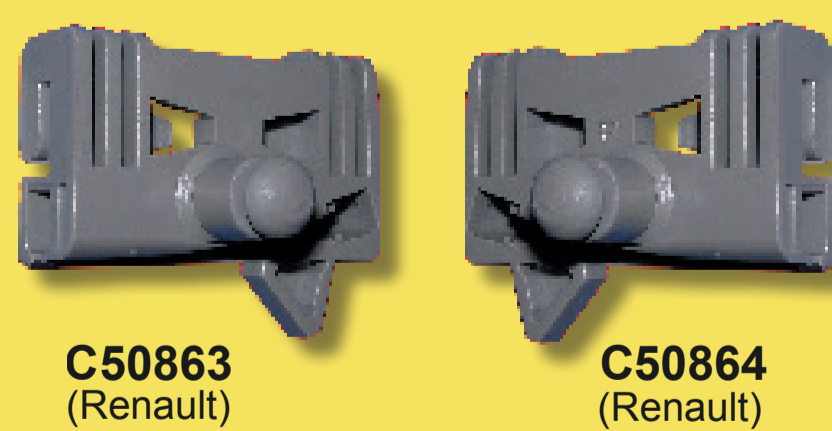

C50863 (Renault)

C50864 (Renault)

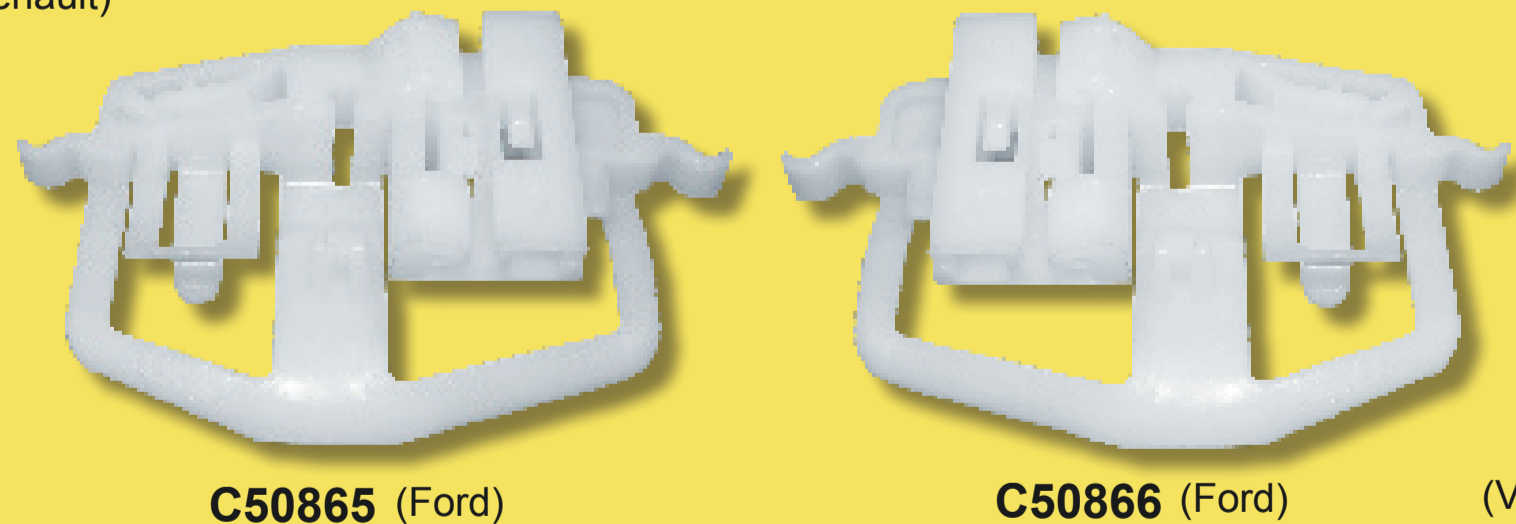

C50865 (Ford)

C50866 (Ford)



C50867 (VW, Seat, Skoda, Citroen)

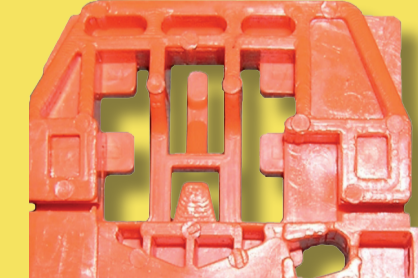

C50882 (VW)

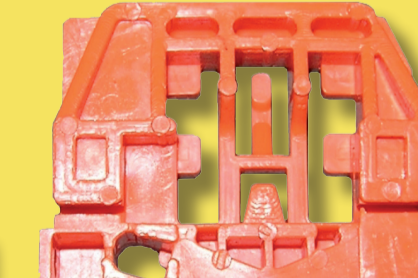

C50883 (VW)

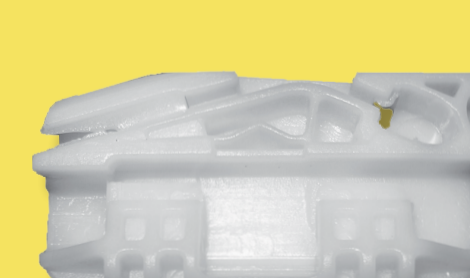

C50886 (VW, Seat, Ford)

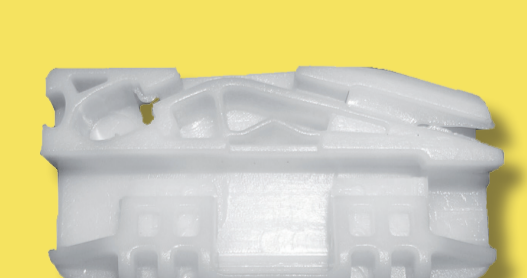

C50887 (VW, Seat, Ford)

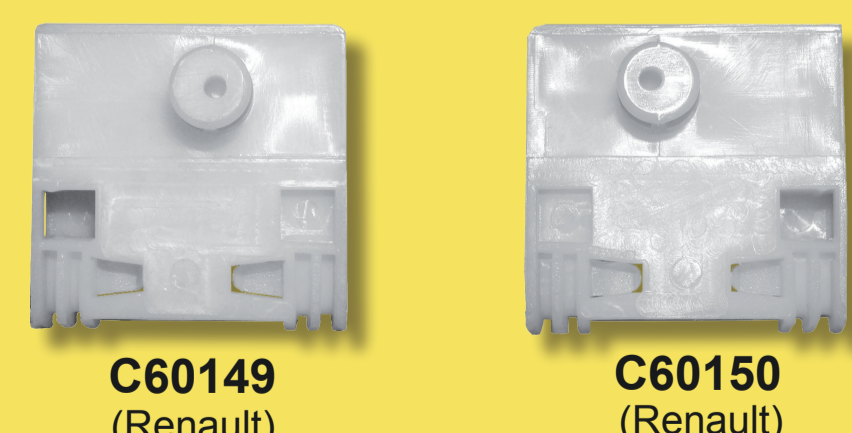

C60149 (Renault)

C60150 (Renault)

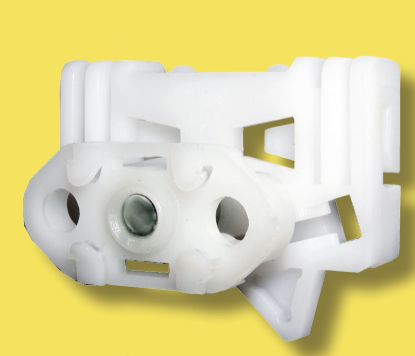

C60376 (Opel)

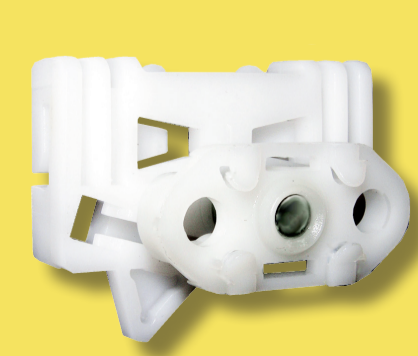

C60377 (Opel)

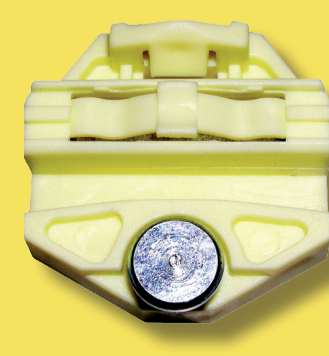

C60378 (Opel, Mercedes)



C60379 (Renault, Dacia, Opel)

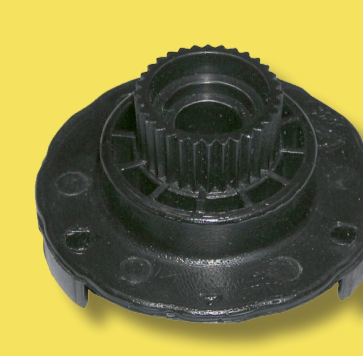

C60380 (Audi, Seat, VW)

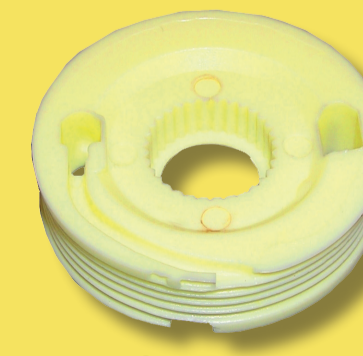

C60381 (VW, Seat, Skoda)

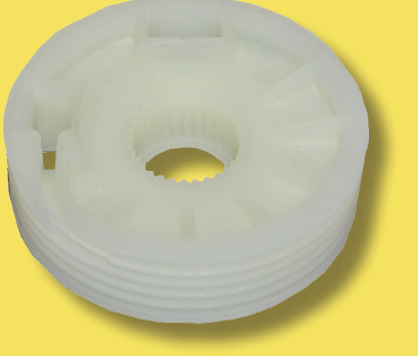

C60382 (VW, Seat)

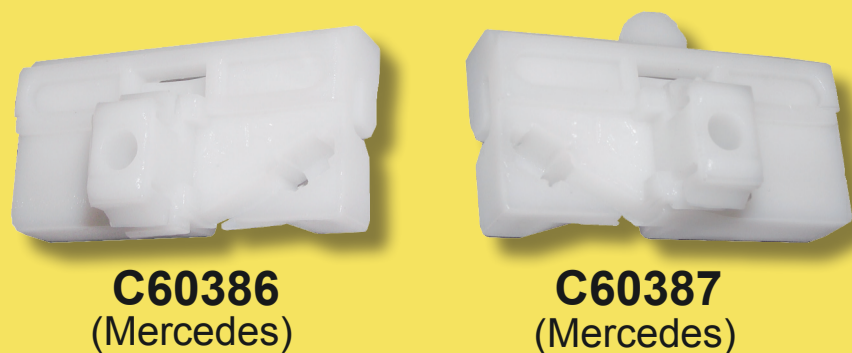

C60386 (Mercedes)

C60387 (Mercedes)



C60389 (Mercedes)

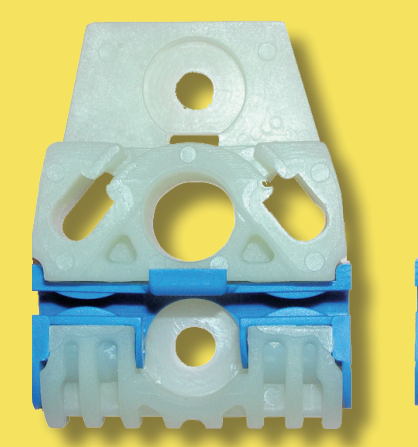

C60390 (VW)

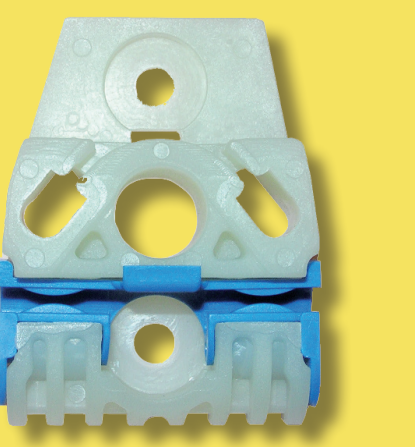

C60391 (VW)

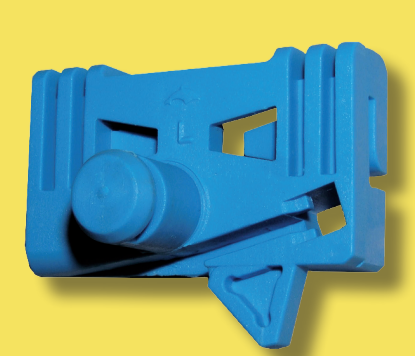

C60397 (Renault)

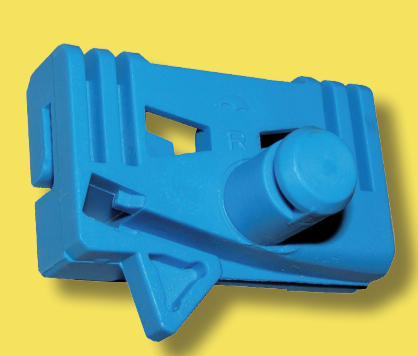

C60398 (Renault)



C60402 (VW)



C60403 (VW)



C60413 (Renault, Dacia, Opel)

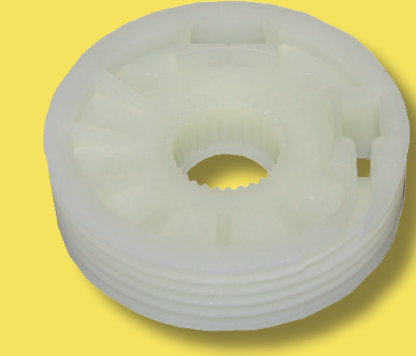

C60414 (VW, Seat)